

 marquis  
COLLECTION



SKYLINE III  
ZERO CLEARANCE DIRECT VENT GAS FIREPLACE

Unit Illustrated is a VRB46N Zero Clearance Direct Vent Gas Fireplace – Natural Gas, ZRB46S2SS Surround (Edge) Stainless Steel, MQSTONE Decorative Stones, ZRB46PL Porcelain Liners, and V46EG Enclosure Grill.

# Enjoy the VIEW

There is nothing subtle about this **Skyline III**. Its pure sophistication makes a statement with wide-view appeal and flexibility. Choose from the rocks and driftwood, decorative stones, cannonballs or ember glass in a choice of colors for a sleek contemporary look.



Unit Illustrated is a VRB46N Zero Clearance Direct Vent Gas Fireplace – Natural Gas, ZRB46S1BL Surround (Frame) Black, MQRBD3 Driftwood Log Set (5 Pce.), ZRB46PL Porcelain Liners, and V46EG Enclosure Grill.



Unit Illustrated is a VRB46N Zero Clearance Direct Vent Gas Fireplace – Natural Gas, ZRB46S2SS Surround (Frame) Stainless Steel, RBCB1 Cannonballs x 14, and ZRB46PL Porcelain Liners.



Unit Illustrated is a VRB46N Zero Clearance Direct Vent Gas Fireplace – Natural Gas, ZRB46S1SS Surround (Edge) Stainless Steel, and ZRB46PL Porcelain Liners.



Unit Illustrated is a VRB46N Zero Clearance Direct Vent Gas Fireplace – Natural Gas, ZRB46S2BL Surround (Frame) Black, MQ46D Three Piece Driftwood Log Set, MQSTONE Decorative Stones, and ZRB46PL Porcelain Liners.

<b>Model</b>	VRB46N/NE	VRB46LP/LPE
<b>Fuel</b>	Natural	Propane
<b>Gas Control</b>	Millivolt / IPI	Millivolt / IPI
<b>Input Max.</b>	23,250 BTU	23,250 BTU
<b>Input Min.</b>	15,750 BTU	17,750 BTU
<b>FE (P.4.1-02)</b>	73.1% / 77.4%	75.7% / 80.3%
<b>Glass Size</b>	40 5/8" x 13 7/8"	40 5/8" x 13 7/8"
<b>Venting</b>	4/7" Flex Vent Only	4/7" Flex Vent Only

## STANDARD FEATURES

- > Hi/Low Millivolt or IPI valve system will operate during power failures
- > Bronze Glass
- > Mobile Home, Bedroom and Bed Sitting Room approved
- > Safety Screen Barrier\*



SAFETY SCREEN BARRIER

## OPTIONAL FEATURES

Choice of Millivolt or IPI electronic ignition system with battery backup, and cold climate switch

**Fan Kit** – Heat activated with variable speed control

**Universal Light Kit** – (accent lighting) Two Lamps

**Liners** – Porcelain Reflective or Fluted

**Surround Trim Kit** – Black, or Stainless; Available in two sizes – Frame and Edge

**Wall Mount Thermostat** – Standard on/off or Programmable 5 day (weekday) and 2 day (weekend)

**Driftwood** – Three Piece Driftwood Set (MQ46D), Four Pieces Driftwood with Four Rocks (MQRBD1), Three Piece Driftwood Log Set (MQRBD4) or Five Piece Driftwood Set (MQRBD3)

**Rock Sets** – Contemporary Collection in Natural, or Multi-Colored

**Decorative Stones or Ember Chunks**

**Decorative Ember Glass** – Glacier Ice, White, Cobalt (Blue), Black or Bronze

**Remote Controls** – Thermostat on/off, Thermostat on/off modulating, Thermostat on/off modulating and fan control



**Enclosure Grill**

\*All gas fireplaces manufactured as of January 1, 2015 include a Safety Screen Barrier.

## ACCESSORIES

### WALL SURROUND

#### FRAME & EDGE

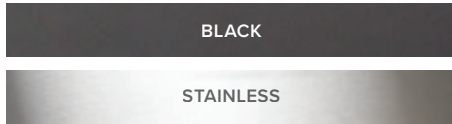

#### STYLING



ROCK COLLECTION



MULTI-COLOR CANNONBALLS



DRIFTWOOD



DECORATIVE STONE



DECORATIVE EMBER GLASS

#### BRICK LINER



FLUTED

## PRODUCT DIMENSIONS

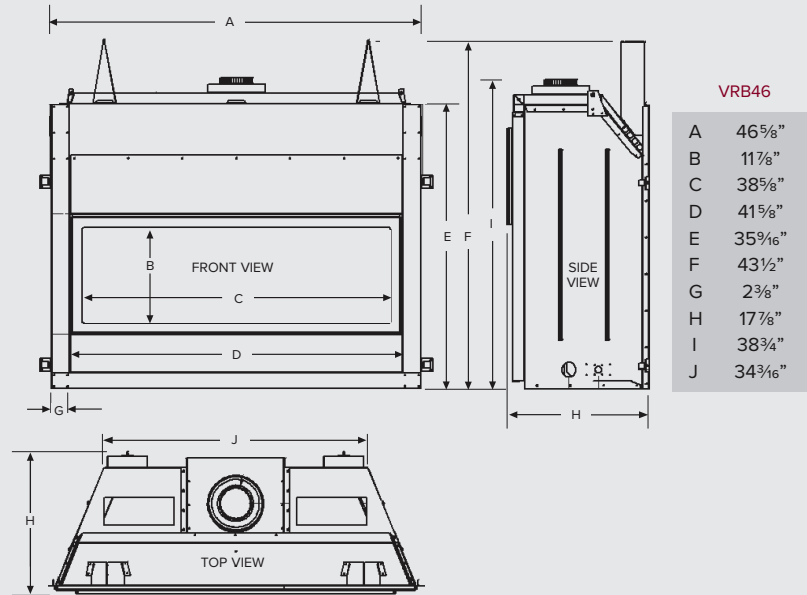

#### VRB46

A	46 <sup>5</sup> / <sub>8</sub> "
B	11 <sup>7</sup> / <sub>8</sub> "
C	38 <sup>5</sup> / <sub>8</sub> "
D	41 <sup>5</sup> / <sub>8</sub> "
E	35 <sup>9</sup> / <sub>16</sub> "
F	43 <sup>1</sup> / <sub>2</sub> "
G	2 <sup>3</sup> / <sub>8</sub> "
H	17 <sup>7</sup> / <sub>8</sub> "
I	38 <sup>3</sup> / <sub>4</sub> "
J	34 <sup>3</sup> / <sub>16</sub> "

Model	Height		Front Width		Depth	
	Actual	Framing	Actual	Framing	Actual	Framing
VRB46	43 <sup>1</sup> / <sub>2</sub> "	43 <sup>3</sup> / <sub>4</sub> "	46 <sup>1</sup> / <sub>4</sub> "	47"	17 <sup>7</sup> / <sub>8</sub> "	18 <sup>1</sup> / <sub>4</sub> **

\* dependant of finishing material used

## WALL SURROUND TRIM KIT

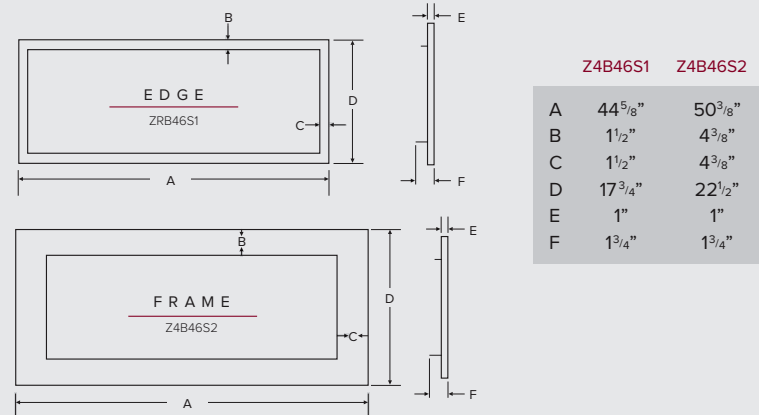

#### Z4B46S1 Z4B46S2

A	44 <sup>5</sup> / <sub>8</sub> "	50 <sup>3</sup> / <sub>8</sub> "
B	1 <sup>1</sup> / <sub>2</sub> "	4 <sup>3</sup> / <sub>8</sub> "
C	1 <sup>1</sup> / <sub>2</sub> "	4 <sup>3</sup> / <sub>8</sub> "
D	17 <sup>3</sup> / <sub>4</sub> "	22 <sup>1</sup> / <sub>2</sub> "
E	1"	1"
F	1 <sup>3</sup> / <sub>4</sub> "	1 <sup>3</sup> / <sub>4</sub> "

## ENCLOSURE GRILL

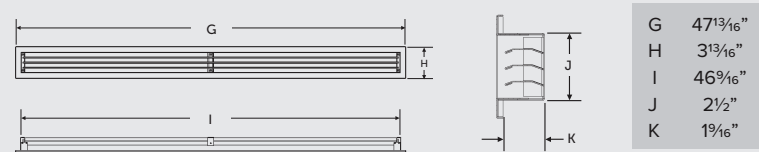

#### V46EG

G	47 <sup>13</sup> / <sub>16</sub> "
H	3 <sup>13</sup> / <sub>16</sub> "
I	46 <sup>9</sup> / <sub>16</sub> "
J	2 <sup>1</sup> / <sub>2</sub> "
K	1 <sup>9</sup> / <sub>16</sub> "

## VENTED CHASE OPTION

When installing a TV above the fireplace, Cool Touch Walls, or reduced Mantel Clearances, the chase of the fireplace must be vented. This can be done by either installing a grill on the front of chase or side grills (for a chase that bumps out in to a room) or be open at the top of the chase. (See illustrations and manual for further information).

Minimum enclosure height for a vented chase is 70" from bottom of fireplace, ventilation of a 105 in<sup>2</sup> of minimum free air opening is required.

Choose between our V46EG Enclosure Grill or Custom Grill (if custom grills are used the louvers cannot slope) or adequate ventilation opening as stated in the manual. Grill or opening must be within 2" of chase top/ceiling.

NOTE: To vent the fireplace chase, removal of vent shields from the fireplace is required.

Framing to ceiling with open front  
2-1/4" x 47"

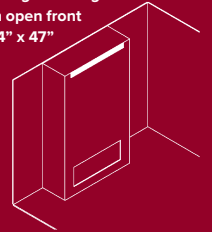

Open chase framing with enclosure min 1-1/4" below ceiling

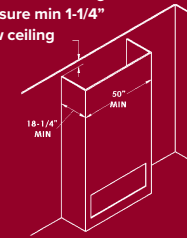

Framing to ceiling with vents at front and back

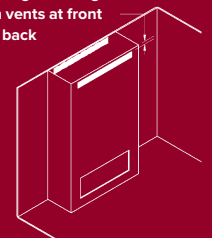

Framing to ceiling with front or side vents

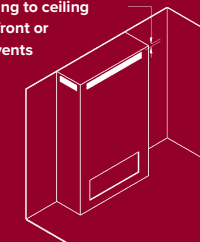

Framing to ceiling, minimum enclosure with front or side vents

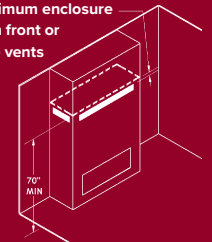

Minimum enclosure with front or side vents

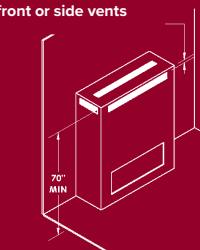

Minimum enclosure with front and back vents

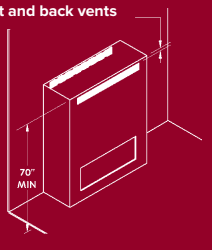

 marquis  
COLLECTION



Marquis maintains a program of continuous testing, refinement and improvements of all its products. Some aspect of units shown here may be changed at any time without notice or obligation.

Certification: Model VRB46 is certified to ANSI Z21.88-2016, CSA 2.33-2016, CGA 2.17-M91 (R2014) vented gas fireplace heater.

\*Components may have to be ordered separately to create a complete unit. Discuss with your local Marquis Dealer for clarification.

