

# Archgard

FIREPLACES



Optima

Direct Vent / Insert Fireplace

## 22 DVI24N

Fireplace Insert Dimensions :  
22-5/8" (575 mm)W x 17-7/8" (454 mm) H x 14-1/8" (mm) D\*

### SPECIFICATIONS

Input Rating	
Natural Gas	16,000-24,000 BTU/hr 4.68-7.03 kW/hr
Propane	17,000-23,000 BTU/hr 4.98-6.74 kW/hr
Efficiencies	
Steady State	85%
AFUE Efficiency	77%
P4	48.77%

### FIREBRICK OPTIONS



22-BRPL-QCG /  
Brick Panel,  
Québec City Grey



22-BRPL-QCR /  
Brick Panel,  
Québec City Red

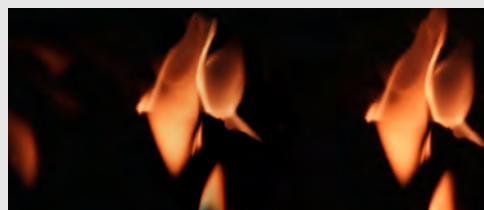

22-BRPL-RG /  
Eternal Flame Reflective  
Ceramic Glass



The log set is key to the natural look and feel of a gas fireplace. The Archgard 22 DVI24N features the ultra-realistic high definition log set to serve as the foundation of the panoramic Wall to Wall Flame. The 22 DVI24N will complete your space whether the flame is lit or not.



The 22 DVI24N can go where others cannot. The smaller dimensions and compact design make it the perfect solution for converting your smaller fireplace into the efficient and convenient centerpiece for your room. Customize your 22 DVI24N with any of the many available aesthetic options to create that perfect look you've been seeking to complement your home.

For more information, pictures, and videos visit [archgard.com](http://archgard.com)

\* See the manual for more information.

\*\* All inserts come standard with barrier screens which attach to the door with very little effort.

Insert name: 22 DVI24N  
Surround: 22 FIFSB (Forged Iron Front, Square, Black)  
Firebrick option: 22- BRPL-QCR (Québec City Red)



## 34 DVI34N

Fireplace Insert Dimensions:  
25-5/8" (651 mm) W x 19-7/8" (505 mm) H x 14-1/8" (359 mm) D\*

### SPECIFICATIONS

Input Rating	
Natural Gas	23,000-34,000 BTU/hr 6.74-9.96 kW/hr
Propane	26,000-34,000 BTU/hr 7.61-9.96 kW/hr
Efficiencies	
Steady State	84%
Afue Efficiency	74%
P4	53.39%

### FIREBACK OPTIONS



34-BRPL-QCG /  
Brick Panel,  
Québec City Grey



34-BRPL-QCR /  
Brick Panel,  
Québec City Red

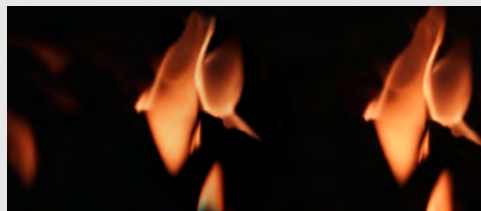

34-BRPL-RG /  
Eternal Flame Reflective  
Ceramic Glass

An Archgard gas insert is the optimal combination of elegance and efficiency. Whether renovating your living room, or perking up a non-traditional location, you can customize your Archgard insert to become the focal point of any room while reducing your heating bill by up to 35%.

For more information, pictures, and videos visit [archgard.com](http://archgard.com)

\* See the manual for more information.

\*\* All inserts come standard with barrier screens which attach to the door with very little effort.



The Archgard 34DVI34N is our most popular millivolt fireplace insert and is sized perfectly for the average fireplace opening. The 34DVI34N can be customized with multiple available options to update your home and complete any décor - all while cutting your heating costs and reducing your environmental impact.

Insert name: 34 DVI34N  
Surround: 34 SKCAB (Surround Kit, Concave Aluminum Black)  
Firebrick option: 34- BRPL- QCR (Québec City Red)



## 40 DVI40N

Fireplace Insert Dimensions:  
28" (711 mm) W x 22-3/8" (568 mm) H x 14-1/8" (359mm) D\*

### SPECIFICATIONS

Input Rating	
Natural Gas	30,000-40,000 BTU/hr 8.79-11.72 KW/hr
Propane	30,000-40,000 BTU/hr 8.79- 11.72 KW/hr
Efficiencies	
Steady State	85%
Afue Efficiency	76%
P4	55.62%

### FIREBACK OPTIONS



40-BRPL-QCG /  
Brick Panel,  
Québec City Grey



40-BRPL-QCR/  
Brick Panel,  
Québec City Red

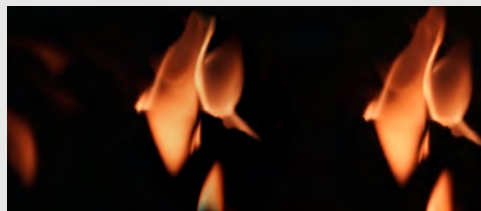

40-BRPL-RG /  
Eternal Flame Reflective  
Ceramic Glass

For more information, pictures, and videos visit [archgard.com](http://archgard.com)

\* See the manual for more information.

\*\* All inserts come standard with barrier screens which attach to the door with very little effort.



The Archgard 40 DVI40N will heat up to 2400 sq ft. ensuring you and your loved ones can enjoy your fire whether in the same room or in another. The German engineered quiet direct drive heat distribution fans operate at 76% efficiency while pushing heat into your home. The panoramic Wall to Wall Flame fills the firebox to create the warm and relaxing ambiance to carry you through those cold winter months.

The Archgard 40 DVI40N is designed to fill even the largest fireboxes and, at 40,000 BTU's, it will heat the largest of spaces.

All Archgard fireplaces are remote ready. Upgrade from the standard on /off switch located on the surround panel with an aftermarket remote control.

Insert name: 40 DVI40N  
Surround: 40 SKLB (Surround Kit, Large Flat Steel Front, Black)  
Firebrick option: 40-BRPL-RG Eternal Flame Reflective Ceramic Glass



TECHNICAL SPECIFICATIONS

	22 DVI24N	34 DVI34N	40 DVI40N
Natural Gas Input Rating	16,000-24,000 BTU/hr 4.68-7.03 kW/hr	23,000-34,000 BTU/hr 6.74-9.96 kW/hr	30,000-40,000 BTU/hr 8.79-11.72 kW/hr
Propane Input Rating	17,000-23,000 BTU/hr 4.98-6.74 kW/hr	26,000-34,000 BTU/hr 7.61-9.96 kW/hr	30,000-40,000 BTU/hr 8.79-11.72 kW/hr
Efficiencies			
Steady State	85%	84%	85%
AFUE Efficiency	77%	74%	76%
P4	48.77%	53.39%	55.62%
Clearance to Combustibles			
Mantle Clearance	34" from bottom of unit to bottom of 6" mantle	37" from bottom of unit to bottom of 6" mantle	43.5" from bottom of unit to bottom of 6" mantle
Surround Side Clearance	1"	1"	3"
Minimum Fireplace Opening Dimensions			
	23" W x 18" H x 15-3/4" D*	27" W x 20" H x 15.1/4" D*	29-5/8" W x 22-1/2" H x 15-3/4"D*
*Add 2" H x 5" W x 1.5" D when using Forged Iron Front			
Viewing Area	23.5" W x 10.5" H	26" W x 12.5" H	28" W x 14.5" H
Vent Size	Two 3" (76mm) vents	Two 3" (76mm) vents	Two 3" (76mm) vents

For more information, pictures, and videos visit [archgard.com](http://archgard.com)

TECHNICAL DIMENSIONS

TOP VIEW

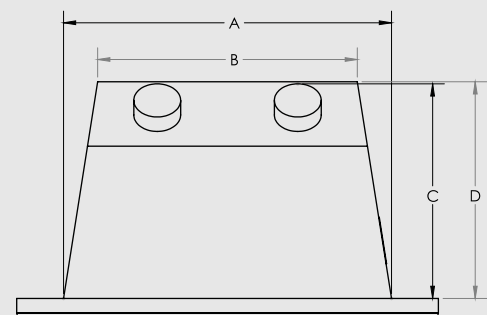

SIDE VIEW

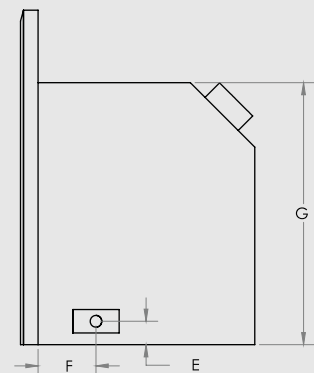

22 DVI24N

A	B	C	D
22-5/8"	13"	14"	14-1/8"
575mm	330mm	356mm	359mm
E	F	G	
1-1/4"	3-3/4"	17-7/8"	
32mm	93mm	454mm	

34 DVI34N

A	B	C	D
25-5/8"	16"	14"	14-1/8"
651mm	406mm	356mm	359mm
E	F	G	
1-1/4"	3-3/4"	19-7/8"	
32mm	93mm	505mm	

40 DVI40N

A	B	C	D
28"	18-1/2"	14"	14-1/8"
711mm	470mm	356mm	359mm
E	F	G	
1-1/4"	3-3/4"	22-3/8"	
32mm	93mm	568mm	



\*\*All inserts come standard with barrier screens which attach to the door with very little effort.

Tested and Approved to North America Standards ANSI Z21.88B-2014/CSA 2.33-2014 and CAN/ CGA-2.17-M91

Quality, Design & Dependability



Start by choosing from our range of alluring louvered inserts - from the economical 22 DVI24N to the deluxe 40 DVI40N. Then complete your space by adding from our assortment of available options. Choose louvers finished in nickel and gold or forged iron fronts in a variety of styles.



Insert name: 34 DVI34N  
Surround: 34 SKBAB (Surround Kit, Bevelled Aluminum Black)  
Firebrick option: 34- BRPL-QCG (Québec City Grey)

SURROUND KITS



Standard Front  
SKBAB / SKCAB



Large Flat Steel Front  
SKLB



4 sided Front  
SK4CAB / SK4BAB

FOR MODEL 22

38 -1/2" W X 25 -1/2" H

Beveled Aluminum **B**  
Concave Aluminum **B**

41-1/4" W X 28-1/2" H

Steel **B**

38-1/2" W X 31-5/8" H

Beveled Aluminum **B**  
Concave Aluminum **B**

FOR MODEL 34

41-1/2" W X 27-3/4" H

Beveled Aluminum **B**  
Concave Aluminum **B**

47-1/2" W X 30-3/4" H

Steel **B**

41-1/2" W X 33-7/8" H

Beveled Aluminum **B**  
Concave Aluminum **B**

FOR MODEL 40

44" W X 29-3/4" H

Beveled Aluminum **B**  
Concave Aluminum **B**

47-1/4" W X 31-3/8" H

Steel **B**

44" W X 35 -7/8" H

Beveled Aluminum **B**  
Concave Aluminum **B**

\*When installing a Forged Iron or Wrought Iron Front to an insert you must allow an extra 2" in height, 5" in width and 2 1/2" in depth.

**N** Nickel **G** Gold **B** Black **P** Pewter

\*\*All inserts come standard with barrier screens which attach to the door with very little effort.

FRONTS & DOORS



Harrison Mills Square Door  
SDSHMB (Black Only)



Forged Iron Front Square  
FIFSB / FIFSP



Forged Iron Front Arch  
FIFAB / FIFAP



Wrought Iron Front Arch  
WIFASDB / WIFASDP

FOR MODEL 22	25-7/8" H x 39-1/8" W	<b>B</b> <b>P</b>	27-7/8" H x 39-1/8" W / 24-7/8" H to shoulder	<b>B</b> <b>P</b>
FOR MODEL 34	27-7/8" H x 42-1/8" W	<b>B</b> <b>P</b>	29-7/8" H x 42-1/8" W / 26-7/8" H to shoulder	<b>B</b> <b>P</b>
FOR MODEL 40	29-7/8" H x 44-1/2" W	<b>B</b> <b>P</b>	31-7/8" H x 44-1/2" W / 28-7/8" H to shoulder	<b>B</b> <b>P</b>

FRONTS & DOORS



Forged Iron Front Square, Bow Pewter  
FIFSBOWSDP/FIFSBOWSDB

FOR MODEL 22	25-7/8" H x 39-1/8" W	<b>B</b> <b>P</b>
FOR MODEL 34	27-7/8" H x 42-1/8" W	<b>B</b> <b>P</b>
FOR MODEL 40	29-7/8" H x 44-1/2" W	<b>B</b> <b>P</b>

Black **B** Pewter **P** Gold **G** Nickel **N**

TYPES OF LOUVERS



Louver kit, Brushed Nickel

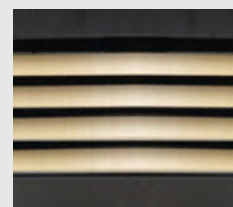

Louver kit, 24K Gold Plated

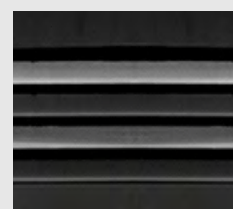

Louver kit, Alternating  
Brushed Nickel and Black.

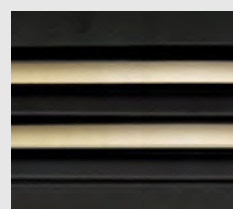

Louver kit, Alternating  
24K Gold Plated and Black.

LOUVER KITS & FILLIGREES

Louver Kit

Filligree Inset

FOR MODEL 22	Alternating <b>B</b> <b>N</b> *	Logo Design <b>B</b> <b>N</b> <b>G</b>
FOR MODEL 34	Alternating <b>B</b> <b>G</b> **	
FOR MODEL 40	Brushed Nickel <b>N</b>	*Brushed Nickel / **24K Plated
	24k Gold Plated <b>G</b>	
	Black <b>B</b>	
	*Brushed Nickel / **24K Plated	

TERMINATION CAP & FLEX LINERS

LKF2

999-INS-TK

999-INS-FL330

999-INS-FL350

FOR MODEL 22	Liner Kit, Flex 2"			
FOR MODEL 34		Vertical Termination cap and flashing.	3"x30' Aluminium flex liner	3"x50' Aluminium flex liner
FOR MODEL 40				



Multi-function remote control with True Feel Smart Thermostat.

For more information, pictures, and videos visit [archgard.com](http://archgard.com)



High Definition Logs

Forged Iron Door

Brick panel, Québec City Grey

Brick panel, Québec City Red

Archgard  
FIREPLACES

[archgard.com](http://archgard.com)

Barrier screen

Forged Iron Door

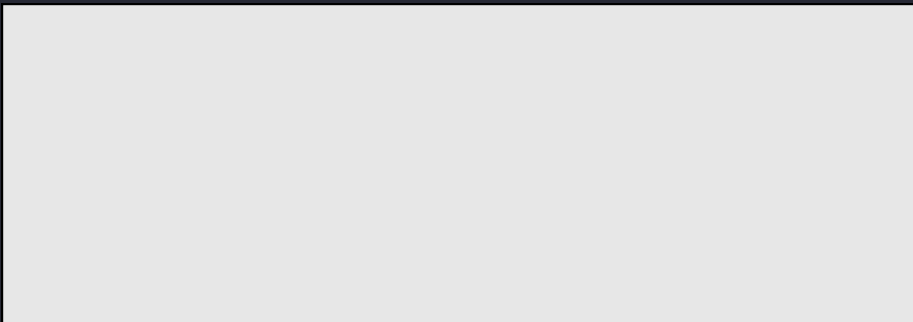

Archgard Fireplace Products  
7116 Beatty Drive Mission BC V2V 6B4  
[archgard.com](http://archgard.com)